







Ferulok[®] Flareless

Bite Type Fittings

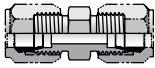
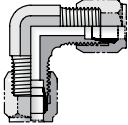
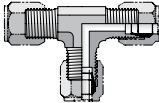
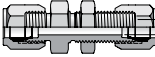
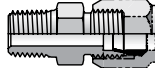
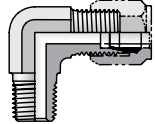
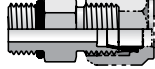
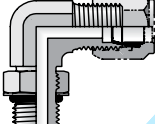
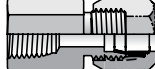
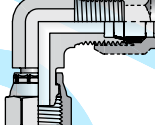
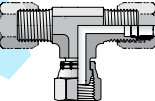
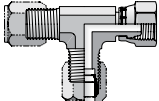

Visual index

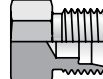
<p>Tube-Tube</p>	 <p>HBU p. L6</p>	 <p>EBU p. L6</p>	 <p>JBU p. L7</p>		
<p>Bulkhead unions</p>	 <p>WBU p. L2</p>				
<p>Tube to male NPTF</p>	 <p>FBU p. L11</p>	 <p>CBU p. L12</p>			
<p>Tube to straight thread UNF</p>	 <p>F5BU p. L10</p>	 <p>C5BU p. L12</p>			
<p>Tube to female NPTF</p>	 <p>GBU p. L13</p>				
<p>Tube to Flareless Swivel</p>	 <p>C6BU p. L8</p>	 <p>S6BU p. L8</p>	 <p>R6BU p. L9</p>		
<p>Nuts & Sleeves Reducers, Caps & Plugs</p>	 <p>C6BU p. L5</p>	 <p>TU p. L5</p>	 <p>TRBU p. L9</p>	 <p>FNU p. L13</p>	 <p>PNU p. L14</p>

KOVANZ S.r.l.

L

How to order Ferulok® fittings

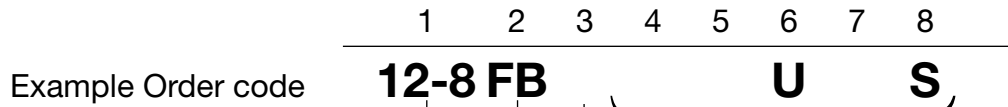

1 Order codes for tube and port thread ends

Dash Size	Tube Size (inch)	Tube Size (mm)	Port Thread Size (inch) BSPP/BSPT/NPT	Port Thread Size UN / UNF
4	1/4	6	1/4	7/16-20
5				1/2-20
6	3/8	8,10	3/8	9/16-18
8	1/2	12	1/2	3/4-16
10	5/8	14,15,16	5/8	7/8-14
12	3/4	18,20	3/4	1 1/6-12
14				1 3/6-12
16	1	25	1	1 5/6-12
20	1 1/4	28,30,32	1 1/4	1 5/8-12
24	1 1/2	35,38	1 1/2	1 7/8-12
32	2	50	2	2 1/2-12

Example:
stud adaptor with nut and ferrule - 3/4" tube to 1/2" NPT port 12-8 FB-U-S

3 Threads and sealing methods

Code	Description
None	NPT/NPTF Thread
3	BSPT Thread
4	BSPP Thread O-Ring & Retainer Ring
42	BSPP Thread EOLASTIC seal 'ED'
5	UN/UNF Thread (O-Ring Seal)
8	Metric Thread O-Ring & Retainer Ring
82	Metric Thread EOLASTIC seal 'ED'
87	Metric ISO 6149 Thread (O-Ring Seal)
63	Swivel Connector BSPT end
64	Swivel Connector BSPP end (O-Ring & Retainer Ring)
642	Swivel Connector BSPP end (EOLASTIC Seal 'ED')
65	Swivel Connector UN/UNF end (O-Ring seal)
68	Swivel Connector Metric end (O-Ring & Retainer Ring)
682	Swivel Connector Metric end (EOLASTIC Seal 'ED')
687	Swivel Connector Metric ISO 6149 end

2 Codes for fitting styles/shapes

Code	Description
AE6	Straight Thread Swivel
B	Nut
C	Male Stud elbow
CC	Extended Male Stud elbow
C6	Swivel Nut Elbow
E	Union elbow
F	Male Stud connector
FF	Extended Male Stud connector
F6	Male Stud Swivel
FN	Cap
FNLBAS	Bleed Adapter Cap
G	Female Connector
H	Straight union
H6	Swivel/Swivel Adapter
J	Union Tee
K	Union Cross
LOHB3	Braze Adapter
LOHX6	Triple-Lok® Swivel/O-Lok® adaptor
M	Female Run Tee
O	Female Branch Tee
PN	Plug
PNLOBA	Bleed Adapter Plug
R	Male Stud Run Tee
R6	Swivel Run Tee
S	Male Stud Branch Tee
S6	Swivel Branch Tee
SBR	Braze Ring
TPL	Parflange® sleeve
TL	Brazed sleeve
TR	Tube End Reducer
TT	Test Point Adapter
TW3	Weld Nipple
V	45° male stud elbow
V6	Swivel Nut 45° Elbow
W	Bulkhead Union
WE	Bulkhead Union Elbow
WJJ	Bulkhead Run Tee
WJT	Bulkhead Branch Tee
WLNML	Bulkhead Locknut
WN	Bulkhead 45° union elbow
XHL6	Triple Lok®/Swivel O-Lok® adaptor
XHLO	Triple Lok®/O-Lok® male adaptor

4 Stud connector seal

Code	Description
O	O-Ring Seal (Assembled on fitting)
ED	Captive EOLASTIC Seal (Assembled on fitting)
No Code	No Seal (O-Ring not assembled on fitting)

5 Hexagon/ Across flats style

Code	Description
M	Metric Hexagon Dimension
No Code	inch Hexagon Dimension

6 Fitting type

Code	Description
U	Parker Ferulok®

7 Tube connection seal ORFS

Code	Description
O	O-Ring Seal (Assembled on Fitting)
No Code	No Seal/O-Ring

8 Fitting material

Code	Description
S	Steel
SS	Stainless Steel
B	Brass

BU Nut

Flareless
SAE 080110

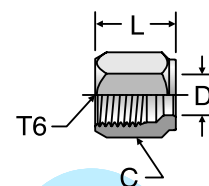

Tube O.D. inch	Thread UN/UNF-2B T6	Hex C inch	Drill D inch	L inch	Weight steel g/1 piece	Ferulok® steel	Ferulok® stainless steel
1/8	5/16-24	3/8	0.13	0.53	5	2 BU-S	2 BU-SS
3/16	3/8-24	7/16	0.19	0.61	5	3 BU-S	3 BU-SS
1/4	7/16-20	9/16	0.26	0.70	14	4 BU-S	4 BU-SS
3/8	9/16-18	11/16	0.38	0.75	18	6 BU-S	6 BU-SS
1/2	3/4-16	7/8	0.51	0.84	32	8 BU-S	8 BU-SS
5/8	7/8-14	1	0.63	0.92	41	10 BU-S	10 BU-SS
3/4	1 1/16-12	1 1/4	0.76	0.97	73	12 BU-S	12 BU-SS
1	1 5/16-12	1 1/2	1.01	1.05	104	16 BU-S	16 BU-SS
1 1/4	1 5/8-12	2	1.26	1.05	222	20 BU-S	20 BU-SS
1 1/2	1 7/8-12	2 1/4	1.51	1.03	254	24 BU-S	24 BU-SS

TU Ferrule

Flareless
SAE 08115A

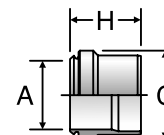

Tube O.D. inch	C inch	A inch	H inch	Ferulok® steel	Ferulok® stainless steel
1/8	0.24	0.13	0.29	2 TU-S	2 TU-SS
3/16	0.31	0.19	0.33	3 TU-S	3 TU-SS
1/4	0.37	0.26	0.36	4 TU-S	4 TU-SS
3/8	0.5	0.38	0.39	6 TU-S	6 TU-SS
1/2	0.66	0.51	0.43	8 TU-S	8 TU-SS
5/8	0.78	0.63	0.44	10 TU-S	10 TU-SS
3/4	0.93	0.76	0.48	12 TU-S	12 TU-SS
1	1.19	1.01	0.48	16 TU-S	16 TU-SS
1 1/4	1.45	1.26	0.48	20 TU-S	20 TU-SS
1 1/2	1.69	1.51	0.48	24 TU-S	24 TU-SS

HBU Union

Flareless / Flareless
SAE 080101

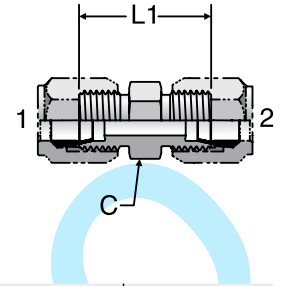

Tube O.D. End 1 inch	Tube O.D. End 2 inch	Hex C inch	L1 inch	Weight steel g/1 piece	Ferulok® steel	Ferulok® stainless steel	Pressure steel bar	Pressure stainless steel bar
1/8	1/8	7/16	1.02	18	2 HBU-S	2 HBU-SS	413	413
3/16	3/16	7/16	1.11	23	3 HBU-S	3 HBU-SS	413	413
1/4	1/4	1/2	1.19	41	4 HBU-S	4 HBU-SS	413	413
3/8	3/8	5/8	1.24	64	6 HBU-S	6 HBU-SS	413	413
1/2	1/2	13/16	1.42	109	8 HBU-S	8 HBU-SS	345	345
5/8	5/8	15/16	1.61	150	10 HBU-S	10 HBU-SS	345	345
3/4	3/4	1 1/8	1.81	281	12 HBU-S	12 HBU-SS	310	310
1	1	1 3/8	1.81	400	16 HBU-S	16 HBU-SS	276	276
1 1/4	1 1/4	1 11/16	1.89	658	20 HBU-S	20 HBU-SS	207	207
1 1/2	1 1/2	2	1.96	785	24 HBU-S	24 HBU-SS	138	138

EBU Union Elbow

Flareless / Flareless
SAE 080201

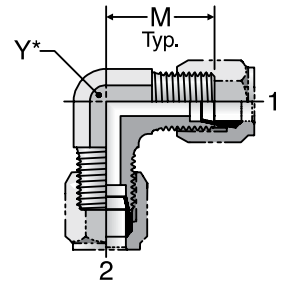

Tube O.D. End 1 inch	Tube O.D. End 2 inch	M inch	Y inch	Weight steel g/1 piece	Ferulok® steel	Ferulok® stainless steel	Pressure steel bar	Pressure stainless steel bar
1/4	1/4	0.89	7/16	50	4 EBU-S	4 EBU-SS	345	345
3/8	3/8	1.05	9/16	86	6 EBU-S	6 EBU-SS	345	345
1/2	1/2	1.25	3/4	150	8 EBU-S	8 EBU-SS	345	345
5/8	5/8	1.42	7/8	218	10 EBU-S	10 EBU-SS	310	310
3/4	3/4	1.58	1 1/16	350	12 EBU-S	12 EBU-SS	276	276
1	1	1.73	1 5/16	518	16 EBU-S	16 EBU-SS	207	207
1 1/4	1 1/4	1.89	1 5/8	981	20 EBU-S	20 EBU-SS	172	172
1 1/2	1 1/2	2.02	1 7/8	1189	24 EBU-S	24 EBU-SS	138	138

JBU Union Tee

Flareless (all three ends)
SAE 080401

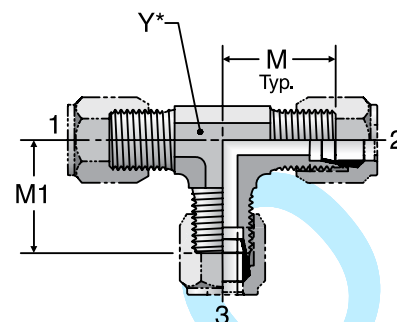

Tube O.D. End 1 inch	Tube O.D. End 2 inch	Tube O.D. End 3 inch	M inch	M1 inch	Y inch	Weight steel g/1 piece	Ferulok® steel	Ferulok® stainless steel	Pressure steel bar	Pressure stainless steel bar
1/4	1/4	1/4	0.89	0.89	7/16	77	4 JBU-S	4 JBU-SS	345	345
3/8	3/8	3/8	1.05	1.05	9/16	123	6 JBU-S	6 JBU-SS	345	345
1/2	1/2	1/2	1.25	1.25	3/4	104	8 JBU-S	8 JBU-SS	345	345
5/8	5/8	5/8	1.42	1.42	7/8	300	10 JBU-S	10 JBU-SS	310	310
3/4	3/4	3/4	1.58	1.58	1 1/16	518	12 JBU-S	12 JBU-SS	276	276
1	1	1	1.73	1.73	1 5/16	713	16 JBU-S	16 JBU-SS	207	207
1 1/4	1 1/4	1 1/4	1.89	1.89	1 5/8	1312	20 JBU-S	20 JBU-SS	172	172
1 1/2	1 1/2	1 1/2	2.02	2.02	1 7/8	1580	24 JBU-S	24 JBU-SS	138	138

WBU Bulkhead Union

Flareless / Flareless
SAE 080601

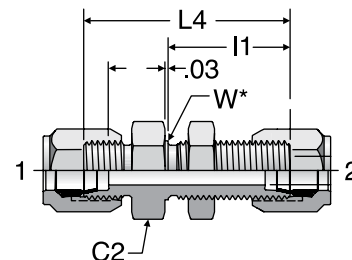

Tube O.D. End 1 inch	Tube O.D. End 2 inch	Hex C2 inch	l1 inch	L4 inch	W inch	Weight steel g/1 piece	Ferulok® steel	Ferulok® stainless steel	Pressure steel bar	Pressure stainless steel bar
1/4	1/4	11/16	1.12	1.89	0.44	68.10	4 WBU-S	4 WBU-SS	413	413
3/8	3/8	13/16	1.17	1.98	0.56	108.96	6 WBU-S	6 WBU-SS	413	413
1/2	1/2	1	1.31	2.22	0.75	167.98	8 WBU-S	8 WBU-SS	345	345
5/8	5/8	1 1/8	1.45	2.48	0.88	222.46	10 WBU-S	10 WBU-SS	345	345
3/4	3/4	1 3/8	1.55	2.72	1.06	372.28	12 WBU-S	12 WBU-SS	310	310
1	1	1 5/8	1.56	2.72	1.31	499.40	16 WBU-S	16 WBU-SS	276	276

C6BU Swivel Nut Elbow

Flareless / Flareless Swivel
SAE 080221

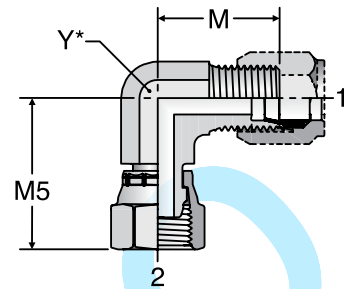

Tube O.D. End 1 inch	Tube O.D. End 2 inch	M inch	M5 inch	Y inch	Weight steel g/1 piece	Ferulok® steel	Ferulok® stainless steel	Pressure steel bar	Pressure stainless steel bar
1/4	1/4	0.89	1.00	7/16	36	4 C6BU-S	4 C6BU-SS	345	345
3/8	3/8	1.05	1.25	9/16	64	6 C6BU-S	6 C6BU-SS	345	345
1/2	1/2	1.25	1.38	3/4	114	8 C6BU-S	8 C6BU-SS	345	345
5/8	5/8	1.42	1.62	7/8	159	10 C6BU-S	10 C6BU-SS	310	310
3/4	3/4	1.58	1.75	1 1/16	254	12 C6BU-S	12 C6BU-SS	276	276
1	1	1.73	2.00	1 5/16	381	16 C6BU-S	16 C6BU-SS	207	207
1 1/4	1 1/4	1.89	2.31	1 5/8	518	20 C6BU-S	20 C6BU-SS	172	172
1 1/2	1 1/2	2.02	2.42	1 7/8	531	24 C6BU-S	24 C6BU-SS	138	138

S6BU Swivel Nut Branch Tee

Flareless / Flareless Swivel
SAE 080202

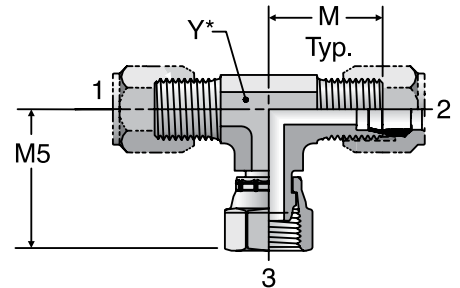

Tube O.D. End 1 inch	Tube O.D. End 2 inch	Tube O.D. End 3 inch	M inch	M5 inch	Y inch	Weight steel g/1 piece	Ferulok® steel	Ferulok® stainless steel	Pressure steel bar	Pressure stainless steel bar
1/4	1/4	1/4	0.89	1.00	7/16	59	4 S6BU-S	4 S6BU-SS	345	345
3/8	3/8	3/8	1.05	1.25	9/16	95	6 S6BU-S	6 S6BU-SS	345	345
1/2	1/2	1/2	1.25	1.38	3/4	173	8 S6BU-S	8 S6BU-SS	345	345
3/4	3/4	3/4	1.58	1.75	1 1/16	390	12 S6BU-S	12 S6BU-SS	276	276
1	1	1	1.73	2.00	1 5/16	454	16 S6BU-S	16 S6BU-SS	207	207

R6BU Swivel Nut Run Tee

Flareless / Flareless Swivel
SAE 080432

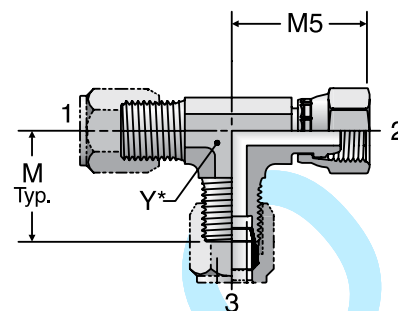

Tube O.D. End 1 inch	Tube O.D. End 2 inch	Tube O.D. End 3 inch	M inch	M5 inch	Y inch	Weight steel g/1 piece	Ferulok® steel	Ferulok® stainless steel	Pressure steel bar	Pressure stainless steel bar
1/4	1/4	1/4	0.89	1.00	7/16	59	4 R6BU-S	4 R6BU-SS	345	345
3/8	3/8	3/8	1.05	1.25	9/16	100	6 R6BU-S	6 R6BU-SS	345	345
1/2	1/2	1/2	1.25	1.38	3/4	177	8 R6BU-S	8 R6BU-SS	345	345
3/4	3/4	3/4	1.58	1.75	1 1/16	495	12 R6BU-S	12 R6BU-SS	276	276
1	1	1	1.73	2.00	1 5/16	826	16 R6BU-S	16 R6BU-SS	207	207

TRBU Tube End Reducer

Tube / Flareless
SAE 080123

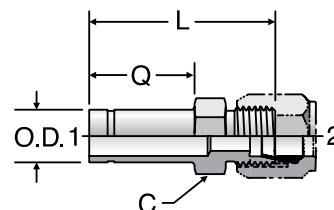

Tube O.D. End 1 inch	Tube O.D. End 2 inch	Hex C inch	L inch	Q inch	Weight steel g/1 piece	Ferulok® steel	Ferulok® stainless steel	Pressure steel bar	Pressure stainless steel bar
3/8	1/4	1/2	1.61	0.88	27	6-4 TRBU-S	6-4 TRBU-SS	413	413
1/2	1/4	9/16	1.73	1	36	8-4 TRBU-S	8-4 TRBU-SS	345	345
1/2	3/8	5/8	1.77	1	45	8-6 TRBU-S	8-6 TRBU-SS	345	345
5/8	3/8	11/16	1.86	1.09	54	10-6 TRBU-S	10-6 TRBU-SS	345	345
5/8	1/2	13/16	1.95	1.09	73	10-8 TRBU-S	10-8 TRBU-SS	310	310
3/4	3/8	13/16	1.94	1.16	68	12-6 TRBU-S	12-6 TRBU-SS	310	310
3/4	1/2	13/16	2.03	1.16	77	12-8 TRBU-S	12-8 TRBU-SS	310	310
3/4	5/8	15/16	2.16	1.16	100	12-10 TRBU-S	12-10 TRBU-SS	310	310
1	1/2	1 1/16	2.05	1.13	114	16-8 TRBU-S	16-8 TRBU-SS	276	276
1	5/8	1 1/16	2.11	1.13	132	16-10 TRBU-S	16-10 TRBU-SS	276	276
1	3/4	1 1/8	2.25	1.13	168	16-12 TRBU-S	16-12 TRBU-SS	276	276
1 1/4	1	1 3/8	2.28	1.16	250	20-16 TRBU-S	20-16 TRBU-SS	207	207
1 1/2	3/4	1 5/8	2.45	1.25	268	24-12 TRBU-S	24-12 TRBU-SS	138	138
1 1/2	1	1 5/8	2.45	1.25	336	24-16 TRBU-S	24-16 TRBU-SS	138	138
1 1/2	1 1/4	1 7/8	2.45	1.25	440	24-20 TRBU-S	24-20 TRBU-SS	138	138

F5BU Straight Thread Connector

Flareless / SAE-ORB
SAE 080120

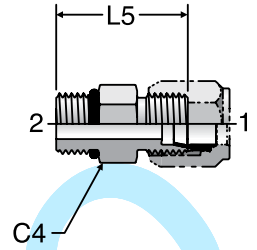

End 1 inch	End 2 UN/UNF-2A inch	Hex C4 inch	L5 inch	Weight steel g/1 piece	Ferulok® steel	Ferulok® stainless steel	Pressure steel bar	Pressure stainless steel bar
1/4	7/16-20	9/16	1.13	27	4 F5BU-S	4 F5BU-SS	413	413
3/8	9/16-18	11/16	1.22	50	6 F5BU-S	6 F5BU-SS	413	413
1/2	3/4-16	7/8	1.38	82	8 F5BU-S	8 F5BU-SS	345	345
5/8	7/8-14	1	1.56	109	10 F5BU-S	10 F5BU-SS	345	345
3/4	1 1/16-12	1 1/4	1.78	195	12 F5BU-S	12 F5BU-SS	310	310
1	1 5/16-12	1 1/2	1.81	250	16 F5BU-S	16 F5BU-SS	276	276

KOVAN S.A.

FBU Male Connector

Flareless / NPTF
SAE 080102

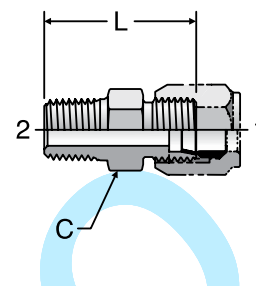

End 1 inch	End 2 NPTF inch	Hex C inch	L inch	Weight steel g/1 piece	Ferulok® steel	Ferulok® stainless steel	Pressure steel bar	Pressure stainless steel bar
1/8	1/8-27	7/16	1.04	18	2 FBU-S	2 FBU-SS	413	413
1/8	1/4-18	9/16	1.24	32	2-4 FBU-S	2-4 FBU-SS	413	413
1/4	1/8-27	1/2	1.12	27	4 FBU-S	4 FBU-SS	413	413
1/4	1/4-18	9/16	1.32	36	4-4 FBU-S	4-4 FBU-SS	413	413
1/4	3/8-18	3/4	1.33	36	4-6 FBU-S	4-6 FBU-SS	413	413
1/4	1/2-14	7/8	1.58	64	4-8 FBU-S	4-8 FBU-SS	413	413
3/8	1/4-18	5/8	1.34	45	6 FBU-S	6 FBU-SS	413	413
3/8	1/8-27	5/8	1.15	45	6-2 FBU-S	6-2 FBU-SS	413	413
3/8	3/8-18	3/4	1.35	59	6-6 FBU-S	6-6 FBU-SS	413	413
3/8	1/2-14	15/16	1.6	91	6-8 FBU-S	6-8 FBU-SS	413	413
1/2	3/8-18	13/16	1.44	77	8 FBU-S	8 FBU-SS	345	345
1/2	1/4-18	13/16	1.44	73	8-4 FBU-S	8-4 FBU-SS	345	345
1/2	1/2-14	7/8	1.69	100	8-8 FBU-S	8-8 FBU-SS	345	345
1/2	3/4-14	1 1/8	1.76	118	8-12 FBU-S	8-12 FBU-SS	276	276
3/4	3/4-14	1 1/8	1.88	182	12 FBU-S	12 FBU-SS	276	276
3/4	1/2-14	1 1/8	1.88	168	12-8 FBU-S	12-8 FBU-SS	276	276
1	1-11 1/2	1 3/8	2.07	272	16 FBU-S	16 FBU-SS	207	207
1	3/4-14	1 3/8	1.88	236	16-12 FBU-S	16-12 FBU-SS	207	207
1 1/4	1 1/4-11 1/2	1 11/16	2.18	499	20 FBU-S	20 FBU-SS	172	172
1 1/2	1 1/2-11 1/2	2	2.28	499	24 FBU-S	24 FBU-SS	172	172

KONVEX



C5BU Straight Thread Elbow

Flareless / SAE-ORB
SAE 080220

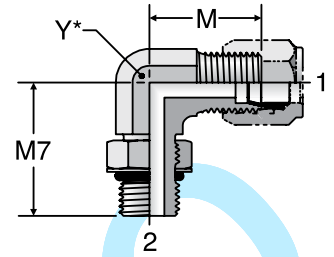

End 1 inch	End 2 UN/UNF-2A inch	M inch	M7 inch	Y inch	Weight steel g/1 piece	Ferulok® steel	Ferulok® stainless steel	Pressure steel bar	Pressure stainless steel bar
1/4	7/16-20	0.89	1.03	7/16	36	4 C5BU-S	4 C5BU-SS	345	345
3/8	9/16-18	1.05	1.25	9/16	59	6 C5BU-S	6 C5BU-SS	345	345
1/2	3/4-16	1.25	1.45	3/4	132	8 C5BU-S	8 C5BU-SS	345	345
5/8	7/8-14	1.42	1.70	7/8	191	10 C5BU-S	10 C5BU-SS	310	310
3/4	1 1/16-12	1.58	1.94	1 1/16	263	12 C5BU-S	12 C5BU-SS	276	276
1	1 5/16-12	1.73	2.05	1 5/16	463	16 C5BU-S	16 C5BU-SS	207	207
1 1/4	1 5/8-12	1.89	2.25	1 5/8	772	20 C5BU-S	20 C5BU-SS	172	172
1 1/2	1 7/8-12	2.02	2.39	1 7/8	944	24 C5BU-S	24 C5BU-SS	138	138

CBU Male Elbow

Flareless / NPTF
SAE 080202

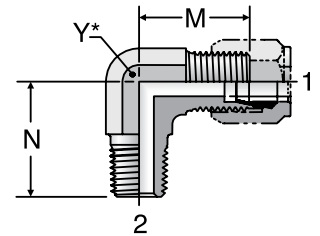

End 1 inch	End 2 NPTF inch	M inch	N inch	Y inch	Weight steel g/1 piece	Ferulok® steel	Ferulok® stainless steel	Pressure steel bar	Pressure stainless steel bar
1/4	1/8-27	0.89	0.78	7/16	36	4 CBU-S	4 CBU-SS	345	345
3/8	1/4-18	1.05	1.09	9/16	64	6 CBU-S	6 CBU-SS	345	345
3/8	3/8-18	1.14	1.22	3/4	95	6-6 CBU-S	6 CBU-SS	345	345
1/2	3/8-18	1.25	1.22	3/4	114	8 CBU-S	8 CBU-SS	345	345
1/2	1/2-14	1.35	1.47	7/8	149	8-8 CBU-S	8-8 CBU-SS	345	345
5/8	1/2-14	1.42	1.47	7/8	168	10 CBU-S	10 CBU-SS	310	310
3/4	3/4-14	1.58	1.59	1 1/16	272	12 CBU-S	12 CBU-SS	276	276
1	1-11 1/2	1.73	1.97	1 5/16	413	16 CBU-S	16 CBU-SS	207	207
1 1/4	1 1/4-11 1/2	1.89	2.38	1 5/8	754	20 CBU-S	20 CBU-SS	172	172
1 1/2	1 1/2-11 1/2	2.02	2.64	1 7/8	926	24 CBU-S	24 CBU-SS	172	172

GBU Female Connector

Flareless / NPTF
SAE 080103

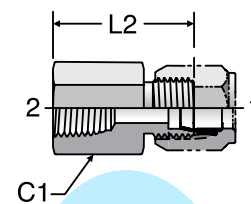

End 1 inch	End 2 inch	Hex C1 inch	L2 inch	Weight steel g/1 piece	Ferulok® steel	Ferulok® stainless steel	Pressure steel bar	Pressure stainless steel bar
1/4	1/8-27	9/16	1.09	32	4 GBU-S	4 GBU-SS	345	345
3/8	1/4-18	3/4	1.31	59	6 GBU-S	6 GBU-SS	345	345
1/2	3/8-18	7/8	1.47	91	8 GBU-S	8 GBU-SS	345	345
5/8	1/2-14	1 1/8	1.77	159	10 GBU-S	10 GBU-SS	310	310
3/4	3/4-14	1 3/8	1.89	250	12 GBU-S	12 GBU-SS	276	276
1	1-11 1/2	1 5/8	2.13	359	16 GBU-S	16 GBU-SS	207	207
1 1/4	1 1/4-11 1/2	2	2.22	636	20 GBU-S	20 GBU-SS	172	172
1 1/2	1 1/2-11 1/2	2 3/8	2.23	667	24 GBU-S	24 GBU-SS	172	172

FNU Cap

Flareless Swivel
SAE 080112

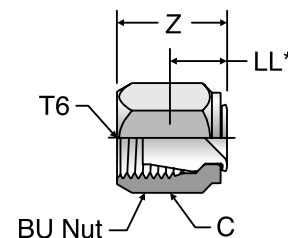

Tube O.D. inch	T6UN/UNF-2B inch	Hex C inch	LL inch	Z inch	Weight steel g/1 piece	Ferulok® steel	Ferulok® stainless steel
1/4	7/16-24	9/16	0.36	0.73	4.54	4 FNU-S	4 FNU-SS
3/8	9/16-18	11/16	0.42	0.80	13.62	6 FNU-S	6 FNU-SS
1/2	3/4-16	7/8	0.44	0.87	27.24	8 FNU-S	8 FNU-SS
5/8	7/8-14	1	0.47	0.98	40.86	10 FNU-S	10 FNU-SS
3/4	1 1/16-12	1 1/4	0.48	1.00	59.02	12 FNU-S	12 FNU-SS
1	1 5/16-12	1 1/2	0.58	1.08	72.64	16 FNU-S	16 FNU-SS
1 1/4	1 5/8-12	2	0.64	1.11	104.42	20 FNU-S	20 FNU-SS

PNU Plug

Flareless
SAE 080109

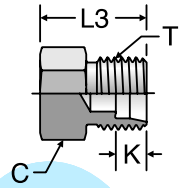

Tube O.D. inch	T Tube End UN/UNF 2A inch	Hex C inch	K inch	L3 inch	Weight steel g/1 piece	Ferulok® steel	Ferulok® stainless steel	Pressure steel bar	Pressure stainless steel bar
1/4	7/16-20	1/2	0.24	0.72	9	4 PNU-S	4 PNU-SS	413	413
3/8	9/16-18	5/8	0.26	0.75	18	6 PNU-S	6 PNU-SS	413	413
1/2	3/4-16	13/16	0.31	0.84	36	8 PNU-S	8 PNU-SS	345	345
5/8	7/8-14	15/16	0.36	0.97	54	10 PNU-S	10 PNU-SS	345	345
3/4	1 1/16-12	1 1/8	0.36	1.09	91	12 PNU-S	12 PNU-SS	310	310
1	1 5/16-12	1 3/8	0.42	1.09	168	16 PNU-S	16 PNU-SS	276	276

KOVAN S.A.